

NPA

New Product Announcement No. 2019-23



FACE RUSH

FACE GROOVING

Shallow Face Grooving Rigid Inserts and Holders



KEY POINT

TaeguTec unveils the **FACE-RUSH** line, new shallow face grooving rigid inserts and holders

One constant challenge machinists deal with when performing face grooving operations is the tool's frequent breakage due to the holder's vulnerability and the difficulty of chip evacuation. To solve this issue, the **FACE-RUSH** line has introduced an innovative clamping and insert design concept.

The insert's anti-rotating triangular grooves on the bottom side and screw clamping design make the insert very robust and stable when seated in the holder. If the cutting edge in use is damaged during machining, the opposite side of the cutting edge can be used in its place.

Increased insert thickness strengthens stiffness, improves stability and prevents abrupt breakage. The insert is clamped by using a screw without an upper jaw. Furthermore, the removal of a lower jaw coupled with the insert's thickness as well as a very rigid system has eliminated breakage of the holder in face grooving applications. Therefore, extremely stable machining is possible even under harsh cutting conditions. The **FACE-RUSH** line can be applied to a wide variety of applications with stable machining and tool life, which will contribute greatly to improving productivity.

Features

- Robust clamping includes anti-rotating triangular grooves on the insert bottom side and strong screw clamping design
 - Insert rotation protection and stable machining
 - The opposite cutting edge can be used in the event of cutting edge breakage during machining
- The thicker insert increases stiffness for protection against breakage and stable cutting
- Holder structure without an upper and lower jaw
 - Easy chip evacuation without the interference of an upper jaw
 - No breakage of the holder due to the lack of a lower jaw
 - One holder type for all insert widths and workpiece shapes
- Wide variety of applications
 - Face grooving and face turning, external grooving, external turning and threading
- COOL-BURST ensures good chip evacuation, improved and stable tool life



Insert features

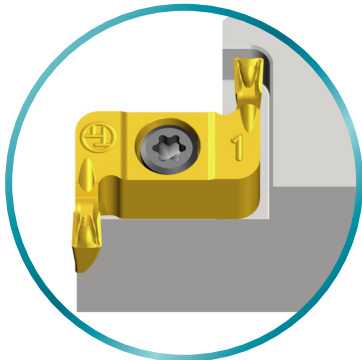

Screw clamping type
even with one damaged edge, the
other edge is usable

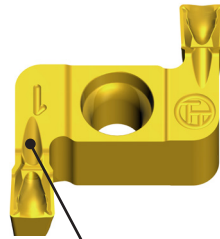

Coolant channel

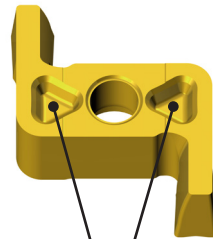

Anti-rotating grooves

Various applications

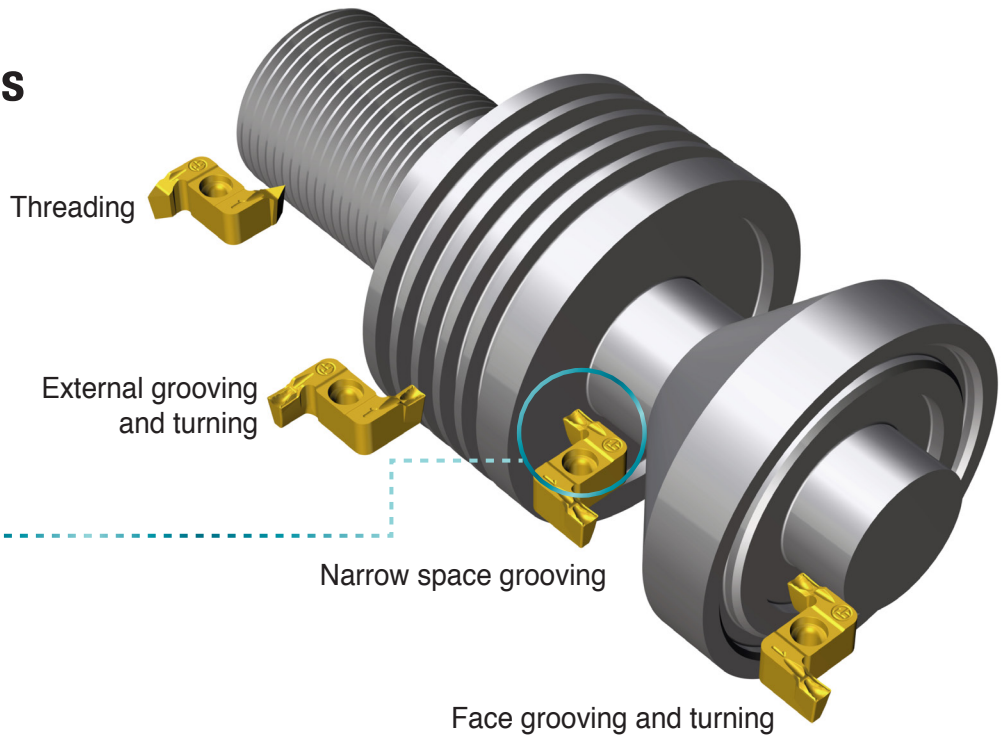
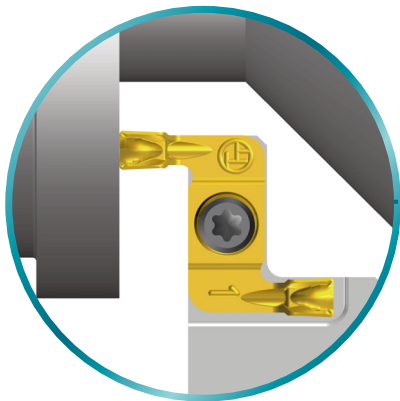

Availability

In stock

Price

Available in the GAL system

Sincerely,
TaeguTec

Bae Dae-wi
Non-Rotating General PM

Sincerely,
TaeguTec

Cha Byung-jae
T-Clamp & Threading Product Manager

Case study 1

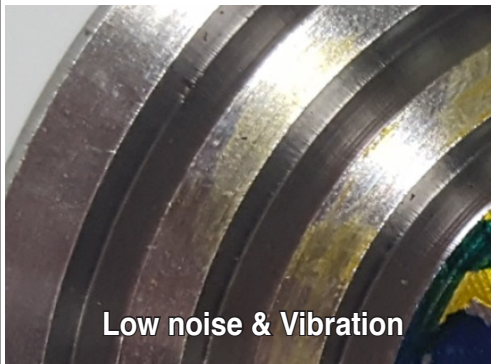
		Competitor	TaeguTec
Material		AISI 1045	
Operation		Face grooving	
Insert		Conventional grooving insert	TDFX 3E-0.3-D24R TT9080
Cutting speed	V (m/min)	200	200
Feed rate	f (mm/rev)	0.11	0.11
Depth of cut	ap (mm)	4	4
Coolant		wet	wet
Machined surface		 Noise & Vibration	 Low noise & Vibration

Case study 2

		Competitor	TaeguTec
Material		AISI 1045	
Operation		Face grooving	
Insert		Conventional grooving insert	TDFX 3E-0.3-D24R TT9080
Cutting speed	V (m/min)	200	200
Feed rate	f (mm/rev)	0.11	0.11
Depth of cut	ap (mm)	4	4
Coolant		wet	wet
Tool life (pass/corner)		10	60

Tool life
(pass/corner)

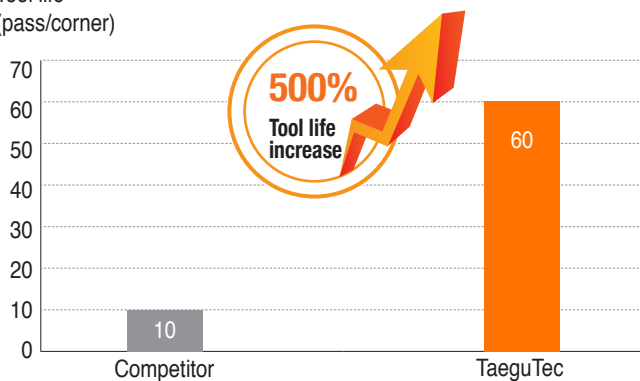

TXFR/L-TB



Holders for shallow face grooving and turning with high-pressure coolant

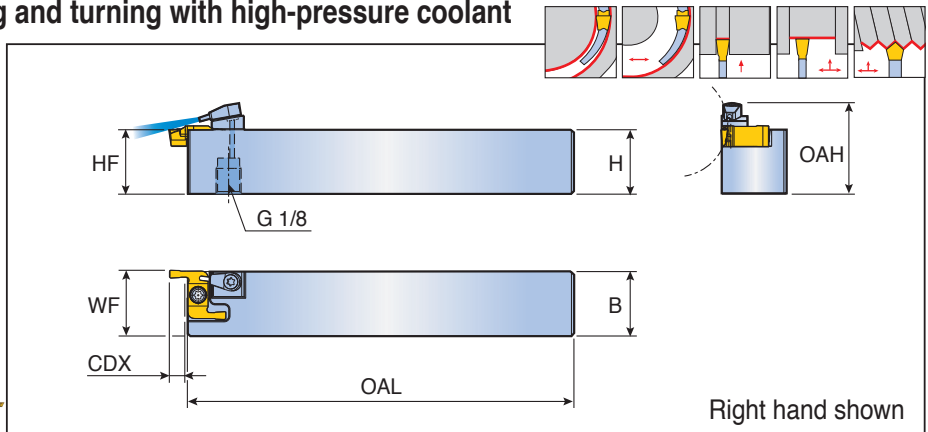
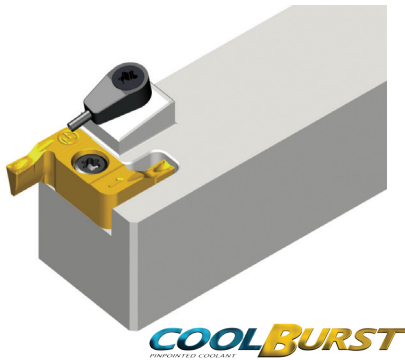

Designation	Dimension (mm)							Insert
	H	HF	B	OAL	OAH	WF	CDX	
TXFR 2525-TB	25	25	25	150	35.5	25.5	6	TDF(G)X ...R
TXFL 2525-TB	25	25	25	150	35.5	25.5	6	TDF(G)X ...L

	70 bar flow rate (ℓ/min)	100 bar flow rate (ℓ/min)	140 bar flow rate (ℓ/min)
TXFL 2525-TB	5-7	7-9	8-10
TXFR 2525-TB	5-7	7-9	8-10

Spare parts

Designation	Screw	Wrench	Cooling unit	
TXFR-TB	TS 35110I	T 15	S-CU-TB	
TXFL-TB	TS 35110IL	T 15	S-CU-TB	

TXFPR/L



Perpendicular holders for shallow face grooving and turning

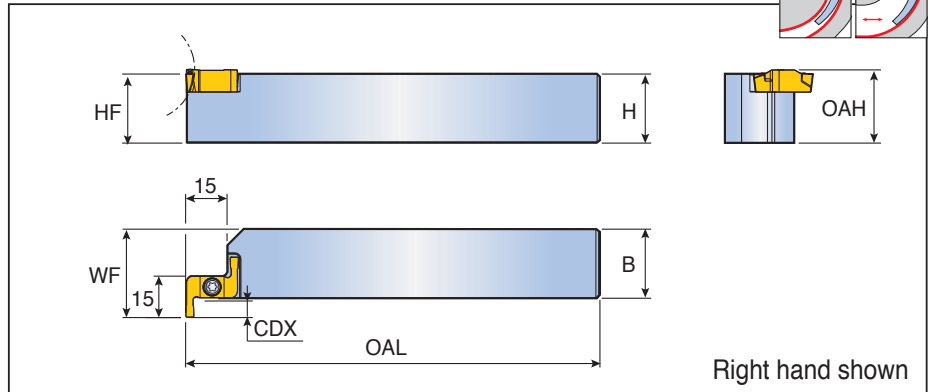
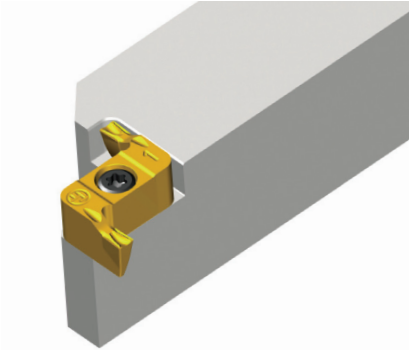

Designation	Dimension (mm)							Insert
	H	HF	B	OAL	OAH	WF	CDX	
TXFPR 2525	25	25	25	150	26.5	32	6	TDFX ...R
TXFPL 2525	25	25	25	150	26.5	32	6	TDFX ...L

Spare parts

Designation	Screw	Wrench		
TXFPR	TS 35110I	T 15		
TXFPL	TS 35110IL	T 15		

TXFPR/L-TB



Perpendicular holders for shallow face grooving and turning with high-pressure coolant

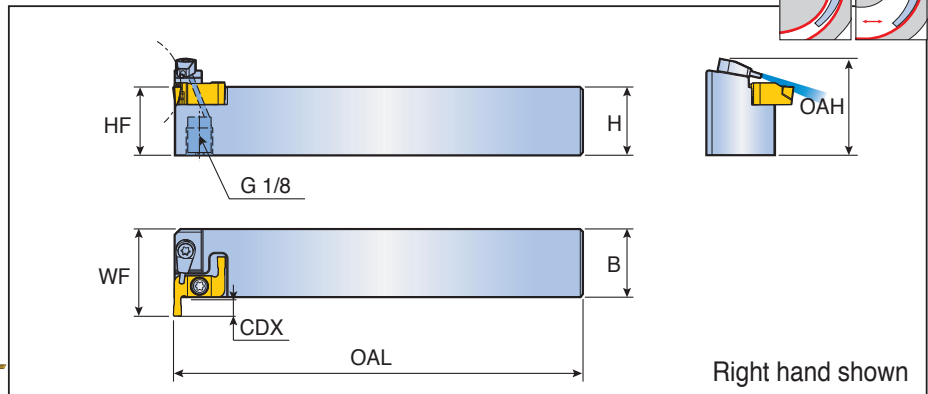
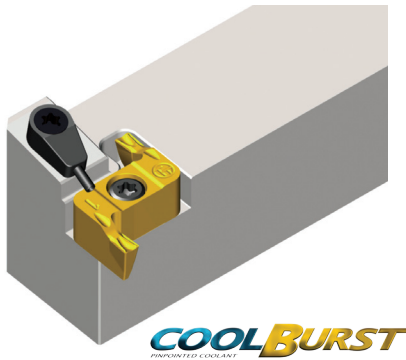

Designation	Dimension (mm)							Insert
	H	HF	B	OAL	OAH	WF	CDX	
TXFPR 2525-TB	25	25	25	150	35.5	32	6	TDFX ...R
TXFPL 2525-TB	25	25	25	150	35.5	32	6	TDFX ...L

	70 bar flow rate (ℓ/min)	100 bar flow rate (ℓ/min)	140 bar flow rate (ℓ/min)
TXFPR 2525-TB	5-7	7-9	8-10
TXFPL 2525-TB	5-7	7-9	8-10

Spare parts

Designation	Screw	Wrench	Cooling unit	
TXFPR-TB	TS 35110I	T 15	S-CU-TB	
TXFPL-TB	TS 35110IL	T 15	S-CU-TB	

KIT COLLECTIONS

These kit products are available in the format listed below.



Cat. No.	Designation	Bill of materials	Qty.
6334867	KISFT-TXFR 2525-TB-3E	TXFR 2525-TB	1
		TDFX 3E-0.3-D24R TT9080	3
6334868	KISFT-TXFR 2525-TB-4E	TXFR 2525-TB	1
		TDFX 4E-0.4-D32R TT9080	3
6334869	KISFT-TXFPR 2525-TB-3E	TXFPR 2525-TB	1
		TDFX 3E-0.3-D24R TT9080	3
6334870	KISFT-TXFPR 2525-TB-4E	TXFPR 2525-TB	1
		TDFX 4E-0.4-D32R TT9080	3



Cat. No.	Designation	Bill of materials	Qty.
6337928	KISFS-TXFR 2525-TB-3E	TXFR 2525-TB	1
		TDFX 3E-0.3-D24R TT9080	20
6337929	KISFS-TXFR 2525-TB-4E	TXFR 2525-TB	1
		TDFX 4E-0.4-D32R TT9080	20
6337930	KISFS-TXFPR 2525-TB-3E	TXFPR 2525-TB	1
		TDFX 3E-0.3-D24R TT9080	20
6337931	KISFS-TXFPR 2525-TB-4E	TXFPR 2525-TB	1
		TDFX 4E-0.4-D32R TT9080	20



Cat. No.	Designation	Bill of materials	Qty.
6338474	KISFF-A-TDFX 3E03R TT9080	TDFX 3E-0.3-D24R TT9080	50
6338475	KISFF-B-TDFX 3E03R TT9080		100
6338476	KISFF-A-TDFX 4E04R TT9080	TDFX 4E-0.4-D32R TT9080	50
6338477	KISFF-B-TDFX 4E04R TT9080		100